

GUIDELINES FOR

WELDING, NDE

AND

HEAT TREATMENT

THIS BOOKLET IS GIVEN AS A GENERAL GUIDELINE TO THE TENDERERS ABOUT WELDING, NDE & HT FOR THE PIPING SYSTEMS, HOWEVER INSTRUCTIONS GIVEN IN THE DRAWINGS & WELDING SCHEDULE ISSUED DURING EXECUTION OF THE WORK SHALL BE FINAL AND BINDING OF THE CONTRACTOR.

BHEL PSSR SCT :

BOOK NO :



BHARAT HEAVY ELECTRICALS LIMITED

(A Government of India Undertaking)

Power Sector – Southern Region

690, Anna Salai, Nandanam, Chennai – 600 035.

BASE MATERIALS

- 1.0 Scope:
- 1.1 This chapter contains tabulations of chemical compositions & mechanical properties of various materials generally used in BHEL sites.
- 2.0 Contents:
 - Table 1 - Pipes (ASME)
 - Table 2 - Tubes (ASME)
 - Table 3 - Forgings (ASME)
 - Table 4 - Castings (ASME)
 - Table 5 - Plates / Sheets (ASME)
 - Table 6 - Pipes (Other specifications)
 - Table 7 - Tubes (Other specifications)
 - Table 8 - Forgings (Other specifications)
 - Table 9 - Barstock
- 3.0 The data are for general information purposes. The corresponding P Numbers are also indicated.
- 4.0 For materials not covered in this chapter, the supplier shall be contacted.

CHEMICAL COMPOSITION AND MECHANICAL PROPERTIES

Table - 1 Pipes

Sl. No	P.NO / Group No.	Material Specification (ASME)	Chemical Composition (%)								Mech. Properties (Min.)		
			C	Mn	P	S	Si	Ni	Cr	Mo	T.S. kg/mm ²	Y.S. kg/mm ²	%E Min
1	P 1/1	SA 106 Gr.B (Remarks: Carbon restricted to 0.25% Max.)	0.30 Max.	0.29-1.06	0.048 Max.	0.058 Max.	0.10 Max	-	-	-	42	25	30
2	P 1/1	SA 672 Gr.B, Cl.22 Max	0.24 Max.	0.9 Max.	0.035 Max.	0.04 Max.	0.15-0.30	-	-	N 0.009 Max.	42.2-50.6	22.5	25
3	P 1/2	SA 106 Gr.C	0.35 Max.	0.29-1.06	0.048 Max.	0.058 Max.	0.10 Max	-	-	-	49	28	30
4	P 4/1	SA 335 P 11	0.15 Max.	0.3-0.6	0.03 Max.	0.03 Max.	0.5 Max.	-	1.0-1.5	0.44-0.65	42	21	30
5	P 4/1	SA 335 P 12	0.15 Max.	0.3-0.60	0.045 Max.	0.045 Max.	0.5 Max.	-	0.8-1.25	0.44-0.65	42	21	30
6	P 5/1	SA 335 P 22	0.15 Max.	0.3-0.61	0.03 Max.	0.03 Max.	0.5 Max.	-	1.9-2.6	0.87-1.13	42	21	30
7	P 8/1	SA 376 TP 321H (Titanium Stabilised)	0.04-0.10	2.0 Max	0.04 Max.	0.03 Max.	0.75 Max.	9.0-13.0	17.0-20.0	-	53	21	35
8	P 8/1	SA 376 TP 304H	0.04-0.10	2.0 Max	0.04 Max.	0.03 Max.	0.75 Max.	8.0-11.0	18.0-20.0	-	53	21	35
9	P 8/1	SA 376 TP 316H	0.04-0.10	2.0 Max	0.04 Max.	0.03 Max.	0.75 Max.	11.0-14.0	16.0-18.0	-	53	21	35
10	P 8/1	SA 376 TP 347H (Cb+Ta Stabilised)	0.04-0.10	2.0 Max	0.04 Max.	0.03 Max.	0.75 Max.	9.0-13.0	17.0-20.0	-	53	21	35

CHEMICAL COMPOSITION AND MECHANICAL PROPERTIES
Table – 2 Tubes

Sl. No	P.NO / Group No.	Material Specification (ASME)	Chemical Composition (%)								Mech. Properties (Min.)		
			C	Mn	P	S	Si	Ni	Cr	Mo	T.S. kg/mm ²	Y.S. kg/mm ²	%E Min
1	P 1/1	SA 192	0.06-0.18	0.27-0.63	0.048 Max.	0.053 Max.	0.25 Max.	-	-	-	33	18	35
2	P 1/1	SA 210 Gr A1	0.27-0.18	0.93 Max	0.048 Max.	0.058 Max.	0.10 Max.	-	-	-	42	26	30
3	P 1/1	SA 179	0.062-0.18 Max.	0.27-0.63	0.048 Max.	0.058 Max.	-	-	-	-	-	-	-
4	P 1/2	SA 210 Gr. C	0.35 Max.	0.29-1.06	0.048 Max.	0.058 Max.	0.10 Max	-	-	-	49	28	30
5	P 1/2	SA 556 Gr C2	0.3 Max.	0.29 Max.	0.048 Max.	0.048 Max.	0.10 Max	-	-	-	49	28	25
6	P 3/1	SA 209 T1	0.10-0.20	0.3-0.8	0.045 Max.	0.045 Max.	0.10-0.50	-	-	0.44-0.65	39	21	30
7	P 3/1	SA 209 T1a	0.05-0.25	0.3-0.8	0.045 Max.	0.045 Max.	0.10-0.50	-	-	0.44-0.65	42	22.4	30
8	P 3/1	SA 209 T1b	0.14 Max.	0.3-0.8	0.045 Max.	0.045 Max.	0.10-0.50	-	-	0.44-0.65	37	20	30
9	P 4/1	SA 213 T11	0.15 Max.	0.30-0.60	0.03 Max.	0.03 Max.	0.5-1.0	-	1.0-1.5	0.44-0.65	42	21	30
10	P 4/1	SA 213 T12	0.15 Max.	0.30-0.61	0.045 Max.	0.045 Max.	0.5 Max.	-	0.8-1.25	0.44-0.65	42	21	30

CHEMICAL COMPOSITION AND MECHANICAL PROPERTIES

Table – 2 Tubes (Contd..)

Sl. No	P.NO / Group No.	Material Specification (ASME)	Chemical Composition (%)								Mech. Properties (Min.)		
			C	Mn	P	S	Si	Ni	Cr	Mo	T.S. kg/mm ²	Y.S. kg/mm ²	%E Min
11	P 5/1	SA 213 T22	0.15 Max.	0.30-0.60	0.03 Max.	0.03 Max.	0.50 Max.	-	1.9-2.60	0.87-1.13	42	21	30
12	P 5/1	SA 213 T5	0.15 Max.	0.30-0.60	0.030 Max.	0.03 Max.	0.50 Max.	-	4.0-6.0	0.45-0.65	42	21	30
13	P 5/2	SA 213 T9	0.15 Max.	0.30-0.60	0.03 Max.	0.03 Max.	0.25-1.00	-	8.0-10.0	0.9-1.10	42	21	30
14	P 8/1	SA 213 TP 321H (Ti Stabilised)	0.04-0.10	2.0 Max.	0.04 Max.	0.03 Max.	0.75 Max.	9.0-13.0	17.0-20.0	-	53	21	35
15	P 8/1	SA 213 TP 304 H	0.04-0.10	2.0 Max.	0.04 Max.	0.03 Max.	0.75 Max.	8.0-11.0	18.0-20.0	-	53	21	35
16	P 8/1	SA 213 TP 304	0.08 Max.	2.0 Max.	0.04 Max.	0.03 Max.	0.75 Max.	8.0-11.0	18.0-20.0	-	53	21	35
17	P 8/1	SA 249 TP 304	0.08 Max.	2.0 Max.	0.04 Max.	0.03 Max.	0.75 Max.	8.0-11.0	18.0-20.0	-	53	21	35
18	P 8/1	SA 688 TP 304	0.08 Max.	2.0 Max.	0.04 Max.	0.03 Max.	0.75 Max.	8.0-11.0	18.0-20.0	-	53	21	35
19	P 8/1	SA 213 TP 316 H	0.04-0.10	2.0 Max.	0.04 Max.	0.03 Max.	0.75 Max.	11.0-14.0	16.0-18.0	2.0-3.0	53	21	35
20	P 8/1	SA 213 TP 347 H (Cb+Ta Stabilised)	0.04-0.10	2.0 Max.	0.04 Max.	0.03 Max.	0.75 Max.	9.0-13.0	17.0-20.0	-	53	21	35

CHEMICAL COMPOSITION AND MECHANICAL PROPERTIES

Table – 3 Forgings

Sl. No	P.NO / Group No.	Material Specification (ASME)	Chemical Composition (%)								Mech. Properties (Min.)		
			C	Mn	P	S	Si	Ni	Cr	Mo	T.S. kg/mm ²	Y.S. kg/mm ²	%E Min
1	P 1/2	SA 105	0.35 Max	0.6-1.05	0.04 Max.	0.05 Max.	0.35 Max.	-	-	-	49	25.2	30
2	P 4/1	SA 182 F12	0.10-0.20	0.3-0.8	0.04 Max.	0.04 Max.	0.1-0.6	-	0.8-1.25	0.44-0.65	49	28	20
3	P 5/1	SA 182 F22	0.15 Max.	0.3-0.6	0.04 Max.	0.04 Max.	0.5 Max.	-	2.0-2.5	0.87-1.13	52.5	31.5	20
4	P 8/1	SA 182 F321 H (Ti Stabilised)	0.04-0.10	2.0 Max.	0.04 Max.	0.03 Max.	1.00 Max.	9.0-12.0	17.0-Min	-	52.5	21	30
5	P 8/1	SA 182 F304 H	0.04-0.10	2.0 Max.	0.04 Max.	0.03 Max.	1.00 Max	8.0-11.0	18.0-20.0	-	52.5	21	30
6	P 8/1	SA 182 F316 H	0.04-0.10	2.0 Max.	0.04 Max.	0.03 Max.	1.00 Max	10.0-14.0	16.0-18.0	2.0-3.0	52.5	21	30
7	P 8/1	SA 182 F347 H (Cb+Ta Stabilised)	0.04-0.10	2.0 Max.	0.04 Max.	0.03 Max.	1.00 Max	9.0-13.0	17.0-20.0	-	52.5	21	30

CHEMICAL COMPOSITION AND MECHANICAL PROPERTIES

Table – 4 Castings

Sl. No	P.NO / Group No.	Material Specification (ASME)	Chemical Composition (%)								Mech. Properties (Min.)		
			C	Mn	P	S	Si	Ni	Cr	Mo	T.S. kg/mm ²	Y.S. kg/mm ²	%E Min
1	P 1/2	SA 216 WCB	0.3 Max.	1.0 Max.	0.04 Max.	0.045 Max.	1.60 Max.	0.5 Max.	0.5 Max.	0.20 Max.	49	25.2	22
2	P 1/2	SA 216 WCC	0.25 Max.	1.20 Max.	0.04 Max.	0.045 Max.	0.60 Max.	0.5 Max.	0.5 Max.	0.20 Max.	49	28	22
3	P 3/1	SA 217 WC1	0.25 Max.	0.5-0.8	0.04 Max.	0.045 Max.	0.6 Max.	-	-	0.45-0.65	45.5	24.5	24
4	P 4/1	SA 217 WC6	0.2 Max.	0.5-0.8	0.04 Max.	0.045 Max.	0.6 Max.	-	1.0-1.5	0.45-0.65	49	28	20
5	P 5/2	SA 217 C 5	0.2 Max.	0.4-0.7	0.04 Max.	0.045 Max.	0.75 Max.	-	4.0-6.5	0.45-0.65	63	42	18
6	P 5/1	SA 217 WC 9	0.18 Max.	0.4-0.7	0.04 Max.	0.045 Max.	0.6 Max.	-	2.0-2.75	0.9-1.20	49	28	20
7	P 8/1	SA 351 CF 8	0.08 Max.	1.5 Max.	0.04 Max.	0.04 Max.	2.0 Max.	8.0-11.0	18.0-21.0	0.5 Max.	49	21	35
8	P 8/1	SA 351 CF 8M	0.08 Max.	1.5 Max.	0.04 Max.	0.04 Max.	1.5 Max.	9.0-12.0	18.0-21.0	2.0-3.0	49	21	30
9	P 8/1	SA 351 CF 8C	0.08 Max.	1.5 Max.	0.04 Max.	0.04 Max.	2.0 Max.	9.0-12.0	18.0-21.0	0.5 Max.	49	21	30
10	P 8/2	SA 351 CH 20	0.20 Max.	1.5 Max.	0.04 Max.	0.04 Max.	2.0 Max.	12.0-15.0	22.0-26.0	0.5 Max.	49	21	30

CHEMICAL COMPOSITION AND MECHANICAL PROPERTIES

Table – 5 Plates / Sheets

Sl. No	P.NO / Group No.	Material Specification (ASME)	Chemical Composition (%)								Mech. Properties (Min.)		
			C	Mn	P	S	Si	Ni	Cr	Mo	T.S. kg/mm ²	Y.S. kg/mm ²	%E Min
1	P 1/1	SA 516 Gr 60	0.21-0.25	1.85-1.20	0.035 Max.	0.04 Max.	0.15-0.40	-	-	N 0.009	56	26	25
2	P 1/2	SA 516 Gr 70	0.35 Max.	0.85-1.20	0.035 Max.	0.04 Max.	0.15-0.40	-	-	N 0.009	49-63	27	21
3	P 1/3	SA 299	0.30 Max.	0.84 Max.	0.035 Max.	0.04 Max.	0.13-0.45	-	-	-	52.5-66.5	29.4	19
4	P 1/2	SA 515 Gr 70	0.35 Max.	1.3 Max.	0.035 Max.	0.04 Max.	0.13-0.45	-	-	-	49.2-63	26.6	21
5	P 4/1	SA 387 Gr 12	0.17 Max.	0.35-0.73	0.035 Max.	0.04 Max.	0.13-0.45	-	0.74-1.21	0.40-0.65	38.5-56.0	23.1	22
6	P 5/1	SA 387 Gr 22	0.15 Max.	0.25-0.66	0.035 Max.	0.035 Max.	0.5 Max.	-	1.88-2.62	0.85-1.1	42-59.5	21	18
7	P 8/1	SA 240 TYPE 321 (Ti Stabilised)	0.08 Max.	2.0 Max.	0.045 Max.	0.03 Max.	1.0 Max.	9.0-12.0	17.0-19.0	-	52.5	21	40
8	P 8/1	SA240 – TYPE 304	0.08 Max.	2.0 Max.	0.045 Max.	0.03 Max.	1.0 Max.	8.0-10.5	18.0-20.0	-	52.5	21	40
9	P 8/1	SA240 – TYPE 316	0.08 Max.	2.0 Max.	0.045 Max.	0.03 Max.	1.0 Max.	10.0-14.0	16.0-18.0	2.0-3.0	52.5	21	40
10	P 8/1	SA240 – TYPE 347 Ca+Ta Stabilised	0.08 Max.	2.0 Max.	0.045 Max.	0.03 Max.	1.0 Max.	9.0-13.0	17.0-19.0	-	52.5	21	40

CHEMICAL COMPOSITION AND MECHANICAL PROPERTIES

Table – 6 Pipes
(Other Specifications)

Sl. No	P.NO / Group No.	Material Specification	Chemical Composition (%)									Mech. Properties (Min.)		
			C	Mn	P	S	Si	Ni	Cr	Mo	V	T.S. kg/mm ²	Y.S. kg/mm ²	%E Min
1	P 1/1	DIN St 35.8	0.17 Max.	0.4- 0.8	0.04 Max.	0.04 Max.	0.10- 0.35	-	-	-	-	36.7- 48.96	24	25
2	P 1/ 1	DIN St 45.8	0.21 Max.	0.45- 1.20	0.04 Max.	0.04 Max.	0.10- 0.35	-	-	-	-	41.8- 54.1	26	21
3	P 1/1	BS 3602 410	0.21 Max.	0.40- 1.20	0.045 Max.	0.045 Max.	0.35 Max.	-	-	-	-	41.82- 56.1	25	22
4	P 1/1	BS 3602 / 460	0.22 Max.	0.80- 1.40	0.045 Max.	0.045 Max.	0.35 Max.	-	-	-	-	46.9- 61.2	28.6	21
5	P 4/1	BS 3604 620- 460 HFS or	0.10- 0.15	0.40 Max.	0.04 Max.	0.04 Max.	0.10- 0.35	-	0.70- 1.10	0.45- 0.65	-	46.9- 62.22	18.36	22
		CDS 620-440	0.10- 0.18	0.40- 0.70	0.04 Max.	0.04 Max.	0.10- 0.35	-	0.70- 1.10	0.45- 0.65	-	44.9- 60.2	29.58	22
6	P 5/1	BS 3604 622 HFS or CDS	0.08- 0.15	0.40- 0.70	0.04 Max.	0.04 Max.	0.5 Max.	-	2.0- 2.5	0.9- 1.2	-	48.8	26.8	17
7	-	BS 3604 HFS 660 or CDS 660	0.15 Max.	0.4- 0.7	0.04 Max.	0.04 Max.	0.10- 0.35	-	0.25- 0.50	0.5- 0.7	0.22- 0.30	47.3	30	17

CHEMICAL COMPOSITION AND MECHANICAL PROPERTIES

Table – 7 Tubes
(Other Specifications)

Sl. No	P.NO / Group No.	Material Specification	Chemical Composition (%)								Mech. Properties (Min.)		
			C	Mn	P	S	Si	Cr	Mo	V	T.S. kg/mm ²	Y.S. kg/mm ²	%E Min
1	P 1/1	DIN St 35.8	0.17 Max.	0.40- 0.80	0.04 Max.	0.04 Max.	0.10- 0.35	-	-	-	36.70- 48.96	24	25
2	P 1/ 1	DIN St 45.8	0.21 Max.	0.40- 1.20	0.04 Max.	0.04 Max.	0.10- 0.35	-	-	-	41.80- 54.06	26	21
3	P 1/1	BS 3059 / 360	0.17 Max.	0.4- 0.8	0.045 Max.	0.045 Max.	0.35 Max.	-	-	-	36.70- 51.00	22	24
4	P 1/1	BS 3059 / 440	0.12- 0.18	0.9- 1.20	0.040 Max.	0.035 Max.	0.10 0.35	-	-	-	44.88- 59.2	25	21
5	P 3/1	DIN 15 Mo3	0.12- 0.20	0.40 0.80	0.035 Max.	0.035 Max.	0.10- 0.35	-	0.25- 0.35	-	45.9- 61.2	27.5	22
6	P 4/1	DIN B Gr. Mo 4	0.10- 0.18	0.4- 0.7	0.035 Max.	0.035 Max.	0.10- 0.35	0.7- 1.10	0.45- 0.65	-	44.88- 60.18	29.6	22
7	P 4/1	BS 3059 / 620	0.10 0.15	0.4- 0.7	0.04 Max.	0.04 Max.	0.10- 0.35	0.7- 1.1	0.45- 0.65	-	46.9- 62.2	18.4	22

CHEMICAL COMPOSITION AND MECHANICAL PROPERTIES

Table – 7 Tubes (Contd.)
(Other Specifications)

Sl. No	P.NO / Group No.	Material Specification	Chemical Composition (%)								Mech. Properties (Min.)		
			C	Mn	P	S	Si	Cr	Mo	V	T.S. kg/mm ²	Y.S. kg/mm ²	%E Min
8	P 5/1	DIN 10 Cr Mo 910	0.08 0.15	0.4- 0.7	0.035 Max.	0.035 Max.	0.5 Max.	2.0- 2.5	0.9- 1.2	-	45.9- 61.2	28.6	20
9	P 5/ 1	BS 3059(622) – 440	0.08- 0.15	0.4- 0.7	0.04 Max.	0.04 Max.	0.5 Max.	2.0- 2.5	0.9- 1.20	-	44.9- 60.18	17.85	20
10	P 5/1	BS 3059(622)-490	0.08- 0.15	0.4- 0.7	0.04 Max.	0.04 Max.	0.5 Max.	2.0- 2.5	0.9- 1.20	-	49.98- 65.0	28.05	20
11	-	DIN 14 Mo V63	0.10- 0.18	0.4- 0.7	0.035 Max.	0.035 Max.	0.10- 0.35	0.3- 0.6	0.5- 0.7	0.22- 0.32	46.9- 62.22	32.6	20

CHEMICAL COMPOSITION AND MECHANICAL PROPERTIES

Table – 8 Forgings
(Other Specifications)

Sl. No	P.NO / Group No.	Material Specification	Chemical Composition (%)										Mech. Properties (Min.)		
			C	Mn	P	S	Si	Ni	Cr	Mo	V	Cu	T.S. kg/mm ²	Y.S. kg/mm ²	%E Min
1	P 1/1	IS 1875 CL II	0.15- 0.25	0.60- 0.90	0.05 Max.	0.05 Max.	0.15- 0.35	0.25 Max.	0.25 Max.	0.05 Max.	0.05 Max.	-	44	24	24
2	P 1/ 1	BS 1503 161 Cr 28	0.25 Max.	0.65- 1.20	0.05 Max.	0.05 Max.	0.15- 0.35	0.40 Max.	0.25 Max.	0.10 Max.	-	0.30 Max.	44.1- 52	22.1	22
3	-	BS 1503 660	0.08- 0.15	0.40- 0.70	0.04 Max.	0.04 Max.	0.10- 0.35	0.3 Max.	0.25- 0.50	0.50- 0.70	0.22- 0.32	0.25 Max.	47.2- 63	29.9	21

CHEMICAL COMPOSITION AND MECHANICAL PROPERTIES

Table – 9 Bar stock
(Other Specifications)

Sl. No	P.NO / Group No.	Material Specification	Chemical Composition (%)									Mech. Properties (Min.)		
			C	Mn	P	S	Si	Ni	Cr	Mo	V	T.S. kg/mm ²	Y.S. kg/mm ²	%E Min
1	P 1/1	IS 1570 - 1508	0.1- 0.2	0.6- 0.9	0.055 Max.	0.055 Max.	0.05- 0.35	-	-	-	-	43	-	25
2	P 1/ 1	IS 226 (St 42)	0.23 Max.	-	0.055 Max.	0.055 Max.	-	-	-	-	-	42- 54	25	23
3	P 1/1	CSN 11416.1	0.2 Max.	0.65 Max.	0.045 Max.	0.045 Max.	0.35 Max.	0.30 Max	0.30 Max.	-	-	41- 50	24	25
4	-	VX22 Cr Mo V121V	0.18- 0.23	0.3- 0.8	0.035 Max.	0.02 Max.	0.1- 0.5	0.3- 0.5	11.5- 11.9	0.8- 1.2	0.25- 0.35	95	60	15

RECEIPT INSPECTION OF WELDING ELECTRODES / FILLER WIRES

1. All electrodes / filler wires received at site stores shall be segregated for type and size of electrode.
2. Ensure that electrode packets received are free from physical damage.
3. Where electrodes are damaged, the same shall be removed from use.
4. Only electrodes identified in the "Rationalized List of Electrodes" are to be accepted.
5. Where filler metals are supplied by manufacturing unit, inspect for damages, if any.
6. Ensure availability of relevant test certificates. Refer tables of chemical compositions and mechanical properties for acceptance.
7. Endorse acceptance / rejection on the test certificate.

STORAGE & IDENTIFICATION OF WELDING

ELECTRODES / FILLER WIRES

- 1.0 Scope
- 1.1 This procedure is applicable for storage of welding electrodes / filler wires used at sites.
- 2.0 Procedure:
 - 2.1 Only materials accepted (based on receipt inspection) shall be taken into account for storage.
 - 2.2 Storage Facility:
 - 2.2.1 The storage facility shall be identified.
 - 2.2.2 Access shall be restricted to authorized personnel.
 - 2.2.3 The storage area shall be clean and dry.
 - 2.2.4 Steel racks may be used for storage. Avoid storing wood inside the storage room.
 - 2.2.5 Maintain the temperature of the storage facility above the ambient temperature. This can be achieved by the use of appropriate heating arrangements.
 - 2.3 The electrodes / filler wire shall be segregated and identified for
 - a. Type of electrode e.g. E7018.
 - b. Size of electrode e.g. Dia 3.15 mm.

2.4 Colour coding for filler wires:

2.4.1 On receipt of GTAW filler wires, codify the filter wires as per table I below . Both ends shall be coloured.

Table - 1

Specification	Brand Name*	Colour Code
RT 1/ 2 Mo (ER80s-D2)	TGSM	Green
RT 1 Cr 1 / 2 Mo (ER80S-B2)	TGS 1CM	Silver grey/White
RT 2 1/ 4 Cr 1 Mo (ER90S-B3)	TGS 2CM	Brown / Red
RT 347 (ER 347)	TGS – 347	Blue

(* or other approved equivalents)

2.4.1.1 Where another set of colour code is followed, maintain a record of coding used

2.4.2 where the filter wire is cut, apply the appropriate colour code at both ends of the piece.

2.4.3 For other filler wires, a suitable colour distinct from table 1 shall be applied.

BAKING AND HOLDING OF WELDING ELECTRODES

- 1.0 Purpose:
 - 1.1 This section details activities regarding baking and holding of welding electrodes used at sites.
- 2.0 Procedure:
 - 2.1 While handling, avoid contact of oil, grease with electrodes. Do not use oily or wet gloves.
 - 2.1.1 It is recommended that not more than two days requirements are baked.
 - 2.2 GTAW Filler Wires:
 - 2.2.1 These wires do not require any baking.
 - 2.3 Covered Electrodes:
 - 2.3.1 Baking and holding:
 - 2.3.1.1 Identify baking oven and holding oven.
 - 2.3.1.2 They shall have a temperature control facility upto 350⁰C for baking oven and 200 Deg. C for holding oven.
 - 2.3.1.3 A calibrated thermometer shall be provided for monitoring temperature.
 - 2.3.2 On opening a packet of electrodes, segregate and place them in the baking oven. Avoid mix up.
 - 2.3.2.1 After loading, raise the baking oven temperature to the desired range as per Table in 2.3.2.5.
 - 2.3.2.2 Note the time when the temperature reaches the desired range. Maintain this temperature for the duration required as per Table in 2.3.2.5.
 - 2.3.2.3 On completion of baking, transfer the electrodes to holding oven, maintain a minimum temperature of 100⁰C till issue.
 - 2.3.2.4 The electrode shall not be subjected to more than two cycles of baking.

2.3.2.5 Maintain a register containing following details :

- a) Brand name (e.g. Supratherme)
- b) Size (e.g Dia 4.0 mm)
- c) Quantity (e.g. 110 pieces)
- d) Time at required temperature ie. Above 250⁰C
- e) Time of Transfer to holding oven. Activities a,b,c to be recorded before loading into the oven.

Baking and Holding Parameters

AWS Classification (*)	Baking		Holding Temperature ⁰ C (@)
	Temperature ⁰ C	Time (Hours)	
E7018	250 – 300	2	100 min
E7018-1	250 – 300	2	100 min
E7018-A1	250 – 300	2	100 min
E8018-B2	250 – 300	2	100 min
E9018-B3	250 – 300	2	100 min
E8018-B2L	250 – 300	2	100 min
E9018-B3L	250 – 300	2	100 min
E309 & E347	250 - 300	1	100 min

Note : (*) For other electrodes, supplier's recommendations shall be followed.

(@) Maintain the temperature in the oven till issue.

2.3.2.6 After issue, maintain the electrodes in a portable oven at a minimum temperature of 65⁰C till use (not applicable for E6013, E309 & E347 electrodes).

2.3.3 Unused, returned electrodes shall be segregated and kept in the holding oven.

SELECTION AND ISSUE OF WELDING ELECTRODES / FILLER WIRES

- 1.0 Purpose:
- 1.1 This procedure details methods for selection and issue of welding electrodes / filler wires for site operations.
- 2.0 Procedure:
- 2.1 Selection:
 - 2.1.1 The type of filler wire / electrode for welding shall be based on the details given in the contract documents like Erection Welding Schedules, drawings, Welding Procedure Specifications as supplied by the Manufacturing Units.
 - 2.1.2 Where not specified by the Manufacturing Units, selection shall be based on the tables enclosed.
 - 2.1.3 Where electrodes / filler wire are not covered in the documents mentioned in 2.1.1, 2.1.2, refer to manufacturing Units.
- 2.2. Issue:
 - 2.2.1 Issue of welding electrodes / filler wires shall be based on authorized Welding Electrodes Issue Voucher.
 - 2.2.2 It is recommended to restrict quantity issued to not more than 4 hours requirements.
 - 2.2.3 Redried low hydrogen electrodes shall be carried to the work spot in a portable oven.
 - 2.2.4 Maintain the temperature in the portable oven at the work spot above 65 Deg. C.
 - 2.2.5 Unused electrodes shall be returned and kept in the holding oven till reissue.

TABLE – 1 SELECTION OF GTAW FILLER WIRE, SMAW ELECTRODE
FOR BUTT WELDS IN TUBES, PIPES, HEADERS

MATERIAL	WELDING PROCESS	P1 GROUP 1 P1 GROUP 2	P3 GROUP 1	P4 GROUP 1	P5 GROUP 1	P8	Cr Mov
P1 Group 1 P1 Group 2	GTAW SMAW	RT 1 / 2 Mo E7018 (ATT) Note – 1					
P3 Group 1	GTAW SMAW	RT 1 / 2 Mo E7018 (ATT)	RT 1 / 2 Mo E7018 A1				
P4 Group 1	GTAW SMAW	RT 1 / 2 Mo E7018 (ATT)	RT 1 / 2 Mo E7018 A1	RT 1 Cr 1/ 2 Mo E8018- B2			
P5 Group 1	GTAW SMAW	RT 1 / 2 Mo E7018 (ATT)	RT 1 / 2 Mo E7018 A1	RT 1 Cr 1/ 2 Mo E8018- B2	RT 2 1/ 4 Cr 1 Mo E9018 – B3		
PS	GTAW SMAW			ERMiCr3 ENiCrFe2	ERNiCr3 ENiCrFe2	RT347 E347	
Cr Mo V Note- 2	GTAW SMAW				RT 2 1/ 4 Cr 1 Mo E9018-B3		RT 2 1/ 4 Cr 1 Mo E9018- B3

Note – 1 E7018 - A1 For P1 Gr 2 + P1 Gr 2 and Dia > 127 mm.

Note – 2 DIN 14MoV63 or equivalent.

**TABLE – 2 SELECTION OF ELECTRODES
FOR WELDING ATTACHMENTS TO TUBES**

TUBE MATERIAL	ATTACHMENT MATERIAL				
	P1 GROUP 1	P3 GROUP 1	P4 GROUP 1	PS GROUP 1	P8
P1 Group 1 P1 Group 2	E7018	E7018	E7018	E7018	E7018-A1
P3	E7018-A1	E7018-A1	E7018-A1	E7018-A1	E7018-A1
P4 Group 1	E8018-B2		E8018-B2	E8018-B2	E7018-A1
P5 Group 1	E9018-B3		E9018-B3	E9018-B3	E7018-A1
P8			E 309 Note – 1	E 309 Note - 1	E347

Note – 1 Used as circumferential attachment only.

**TABLE – 3 SELECTION OF ELECTRODES, PREHEAT, PWHT
FOR ATTACHMENT TO ATTACHMENT WELDS**

(Seal bands, High crown bars, End bars,
End bar lifting lugs and Collector plates etc.)

MATERIAL	WELDING REQUIREMENTS	P1	P4	P5	P8 GRUP 1	P8 GROUP 2
P1	Electrode Preheat PWHT	E7018 Nil Nil				
P4	Electrode Preheat PWHT	E7018 (Note-2) Nil (Note – 2) Nil (Note – 2)	E8018-B2 Nil Nil			
P5	Electrode Preheat PWHT	E7018 Note 1 & 2 Nil (Note-2)	E8018-B2 Note-1 Nil	E9018-B3 Note-1 Nil		
P8	Electrode Preheat PWHT	E309 Nil Nil	E309 Nil Nil	E309 Nil Nil	E347 Nil Nil	E309 Nil Nil

- Note : 1. When P5 material thickness is more than 10mm, 150 Deg.C preheat is required.
2. Electrode, Preheat and PWHT requirement for welding end bar lifting lug are as follows:

END BAR LIFTING LUG	END BAR	ELECTRODE	PREHEAT DEG.C	PWHT DEG.C
P1	P4	E8018-B2	120	650 – 680
P1	P5	E9018-B3	150	680-720

**TABLE – 4 SELECTION OF ELECTRODES FOR WELDING NOZZLE ATTACHMENTS,
HANDHOLE PLATE, RG PLUG ETC TO HEADERS, PIPES**

HEADER, PIPE MATERIAL	ATTACHMENT MATERIAL				
	P1	P3	P4	P5	P8
P1	E7018 (ATT)	-	E7018 (ATT)	-	ENiCrFe2
P4	-	-	E8018-B2	E8018-B2	-
P5	-	-	-	E9018-B3	ENiCrFe2
Cr Mo V Note-1	-	-	-	E9018-B3	ENiCrFe2

**TABLE – 5 SELECTION OF ELECTRODES FOR NON-PRESSURE PARTS
(INCLUDING STRUCTURES)**

MATERIAL	ELECTRODES
P1 + P1 Carton Steel + P1 Carton + Carton Steel Steel	a. For butt welds, upto 6mm including : E6013
	Over 6 mm : E7018
	b. For fillets, upto 8 mm including : E6013
	Over 8 mm : E7018
	E6013 or E7018
	E8018-B2

WELDER QUALIFICATION

1.0 Scope:

1.1 This chapter details the procedure for qualification of welder at site.

2.0 Contents:

1. Qualification of Welders at Site.
2. Table-1 – Welder qualification Requirements.
3. Record of Welder Performance Qualification Tests.
4. Figure- 1 Fillet Weld Break Specimen.
Figure-2 Method of Rupturing.
Figure-3 Positions.
Figure-4 Plate Butt Weld specimen.
Figure-5 Pipe Butt Weld Specimen.
Figure-6 Bend Specimen.
Figure-7 Bend Jig.

QUALIFICATION OF WELDERS AT SITES

- 1.0 Base Metal:
 - 1.1 For selection refer tables in chapter II.
- 2.0 Test coupon:
 - 2.1 Depending on the range to be qualified, choose the appropriate test coupon from table-1.
 - 2.2 For plate butt welds, details of edge preparation shall be as per Figure-4.
 - 2.3 For pipe butt welds, details of edge preparation shall be as per Figure-5.
 - 2.4 For structural tack welds, refer Figure-1.
- 3.0 Requirement of Tests:
 - 3.1 For Structural Tack Welders:
 - 3.1.1 Break Test as per Figure-2.
 - 3.2 For Plate Butt Welds:
 - 3.2.1 Minimum of 2 specimens for bend test; one for root bend and other for face bend. Width of specimen shall be 38 mm for plate thickness upto 9.5 mm. For thickness greater than 9.5 mm, width of specimens shall be 10 mm and they shall be side bend tested.
 - 3.3 For Pipe Welder:
 - 3.3.1 The order of removal of test specimens shall be as per Figure-6.

3.3.2 For width and number of bend specimens, refer table below:

TABLE

OD	W	No. of Bend Specimens		
		Face	Root	Side
> 101.6	38.0	2	2	(**)
50.8 – 101.6	19.0	2	2	(**)
< 50.8	9.5	2	2	(**)
<= 25.4	(+ +)	2	2	-

(**) for thickness greater than 9.5 mm, side bend test of width 9.5 mm may be substituted.

(++) Cut into 4 equal sections (with allowance for saw cuts or machine cutting); sharp corners to be rounded off.

OD Outer diameter of pipe in mm

W Width of bend test specimen in mm

3.4 For bend jig refer Figure-7, for thickness of bend specimen 9.5 mm; for other thicknesses (t) the dimension shall be as below:

$$A = 4t$$

$$B = 2t$$

$$C = 6t + 3.2 \text{ mm}$$

$$D = 3t + 1.6 \text{ mm}$$

The above values are nominal.

3.5 Radiographic examination of test welds may be carried out in lieu of bend tests. Procedure and acceptance criteria are as per NDE Manual.

4.0 Essential Variables:

4.1 Changes to the following variables require requalification.

4.1.1 Process:

Example: Change from GTAW to SMAW or vice versa.

4.1.2 Joint:

A Change from one type of bevel to another.

Example: vee bevel to u bevel.

4.1.3 Base Metal:

A change in thickness or pipe diameter beyond the limits prescribed in Table-1.

4.1.4 Filler Metal:

A change from one F number to another F number, except as specified in table-1,

4.1.5 Positions:

Note: This procedure envisages qualification of welders to perform in all positions. Deviation to this are not recommended.

4.1.6 Gas:

Note: This procedure envisages test to pre-prescribed gas as for production welds.
Deviation to this are not recommended.

4.1.7 Electrical Characteristics:

- a. AC to DC and vice versa.
- b. In DC, DCEN (Electrode Negative) to DCEP (Electrode Positive) and vice versa.

4.1.8 Technique:

Note:- This procedure envisages only use of uphill progression technique.

5.0 Acceptance Criteria:

5.1 Structural Tack Welding:

5.1.1 No cracks.

5.1.2 No lack of fusion.

5.1.3 Undercut not exceeding 1 mm.

5.1.4 Not more than 1 porosity (max. diameter of porosity 2 mm).

5.2 Plate / pipe Welding:

5.2.1 Visual Inspection:

- a. No cracks.
- b. No lack of fusion or incomplete penetration.
- c. Not more than 1 porosity in a length of 100 mm of length of weld (max. porosity diameter 2 mm).

5.2.2 Bend Test results:

The convex surface of the bend test specimen shall be visually examined for surface discontinuities. For acceptance, the surface shall contain no discontinuities exceeding the following dimensions.

1. 3 mm measured in any direction on the surface.
2. The sum of the greatest dimensions of all discontinuities exceeding 1 mm but less than or equal to 3 mm, shall not exceed 10 mm.
3. The maximum corner crack of 6 mm, except when that corner crack resulted from visible slag inclusion or other fusion type discontinuities, then the 3 mm maximum shall apply. Specimens with corner cracks exceeding 6 mm with no evidence of slag inclusions or other fusion type discontinuities shall be disregarded, and a replacement test specimen from the original weldment shall be tested.

6.0 Retests :

6.1 A welder who fails to meet the acceptance criteria for one or more test specimens, may be retested as per this procedure after adequate practice.

7.0 Validity :

7.1 When a welder meets the requirements of this procedure, the validity will be for a maximum of 2 years from the date of test, limited to Validity specified by statutory authority, as applicable.

7.2 The validity may be extended by one year each time, based on satisfactory performance.

8.0 Requalification :

8.1 Requalification is required for the following :

- a. Where there is a specific reason to doubt the skill of the welder.
- b. Due to non-engagement of the welder for a continuous period of 6 months.

9.0 Records ;

9.1 The welding in charge at site shall maintain the following records.

- A. Record of welder performance Qualification Test (as per format).
- B. Register of qualified welders (employer-wise) containing the following details :
 - 1. Name of welder.
 - 2. Age.
 - 3. Tested for pipe / plate / tack.
 - 4. Performance Test No.
 - 5. Validity.
 - 6. Welder Code.
 - 7. Remarks.

The above register shall be updated for deletions also.

9.2 Copies of welder identity card (including details as in 9.1 B and relevant variables qualified).

9.3 Pertinent radiography reports.

10.0 Enclosures :

- 1. Table – 1 - Welder qualification Requirements.
- 2. Record of Welder Performance Qualification Test.
- 3. Figure-1 - Structural Tack weld specimen.
- 4. Figure – 2 - Break Test.
- 5. Figure – 3 – Weld Positions.
- 6. Figure – 4 - Plate Butt Weld Specimen.
- 7. Figure – 5 - Pipe Butt Weld Specimen.
- 8. Figure – 6 - Order of Removal of Test Specimen.
- 9. Figure – 7 - Bend Jig

WELDER'S QUALIFICATION REQUIREMENTS

TABLE - 1

S L. N O	TEST FOR	BASE METAL Note -1	TEST COUPON DIMENSION OD, t	ELECTRODE TO BE USED Note 2.4	WELD POSITIONS	REFEREN CE FIGURE	RANGE QUALIFIED DIA. & T	POSI TION QUA LIFI ED	ELECTROD E QUALIFIED Note 2,4 REMARKS	
1.	Structural Tack	P1 Gr1	t=10 mm OR 12 mm	(E 6013 F2)	3F & 4F	Fig. 1 & 2	T = Unlimited	ALL	F2, F1	Refer Fig.1,3
				(E 7018) F4	3F & 4F	-do-	T = Unlimited	ALL	F4 & Below	
2.	Plate Welder (Structural)	-do-	t>=>25 mm	F4	3G & 4G	Fig . 3	T=>3.2 mm	ALL	F4 & Below	
			t>25 mm	F4	3G & 4G	-do-	T>3.2 mm <=2t	ALL	F4 & Below	
3.	Plate Welder (Other than Structural)	-do-	t>=>25 mm	F4	2G 3G & 4G	-do-	T = Unlimited OD=>600 mm	ALL	F4 & Below	
			t>25 mm	F4	2G 3G & 4G	-do-	T<=2t OD=>600 mm	ALL	F4 & Below	
4.	Pipe Welder	-do-	OD=>25 mm	F4	6G	-do-	OD=> Above	ALL	F4 & Below	
			OD=>25 mm & <=73 mm	F4	6G	-do-	OD & 25 mm	ALL	F4 & Below	
			OD>=73 mm	F4	6G	-do-	OD>73 mm T <=2t	ALL ALL	F4 & Below F4 & Below	
			t<19 mm	F4	6G	-do-	T= Unlimited	ALL	F4 & Below	
			t.>=19 mm	F4	6G	-do-				

TACK WELDER QUALIFICATION

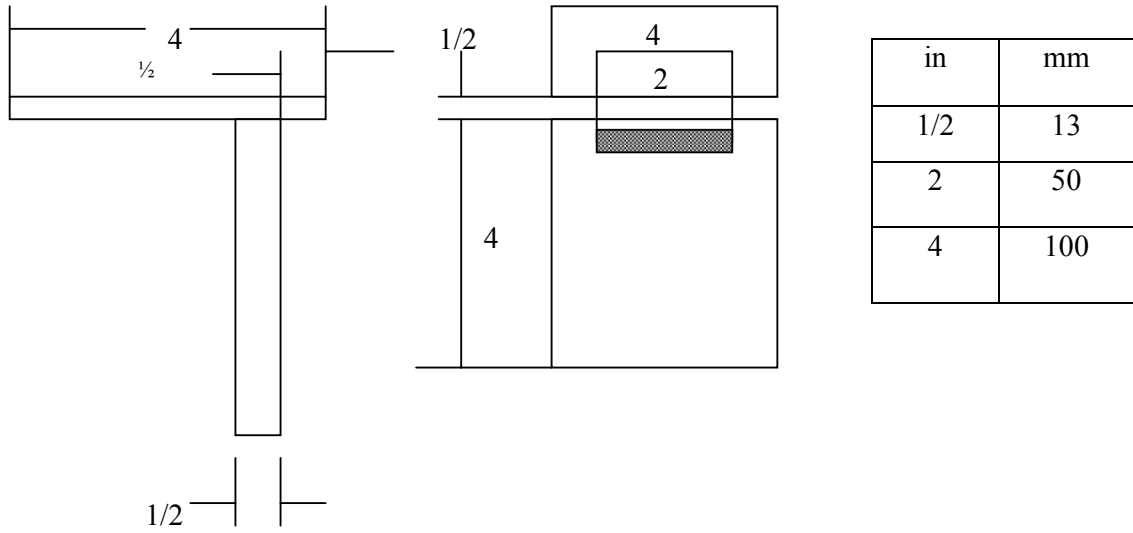

Fig 1 – Fillet Held Break specimen

FORCE

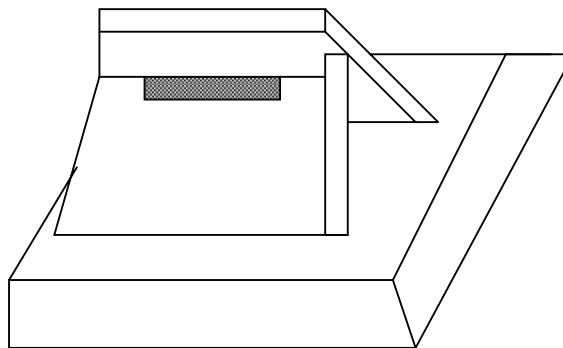
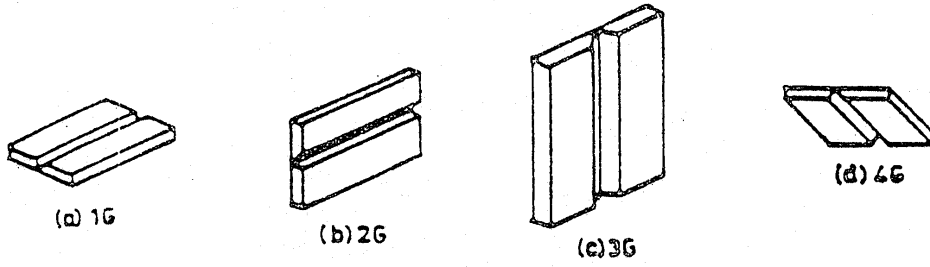
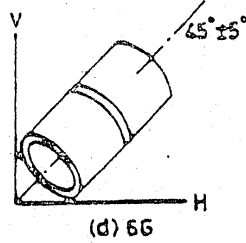
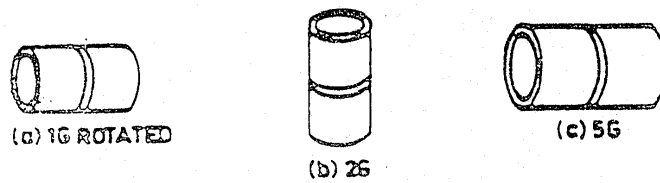

Fig – 2 – Method of Rupturing

Fig. 3 - POSITIONS



GROOVE WELDS IN PLATE



GROOVE WELDS IN PIPE

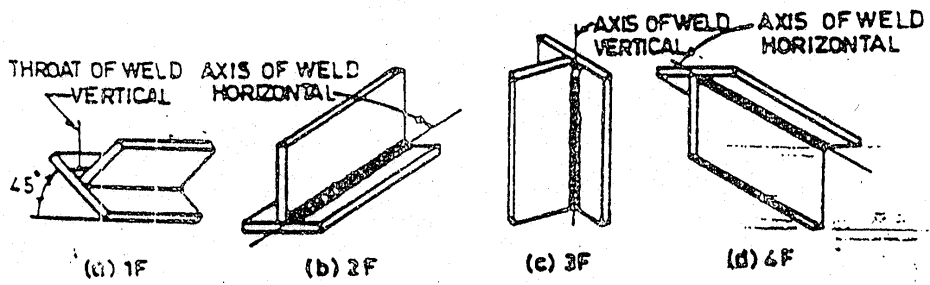

FILLET WELDS PLATE

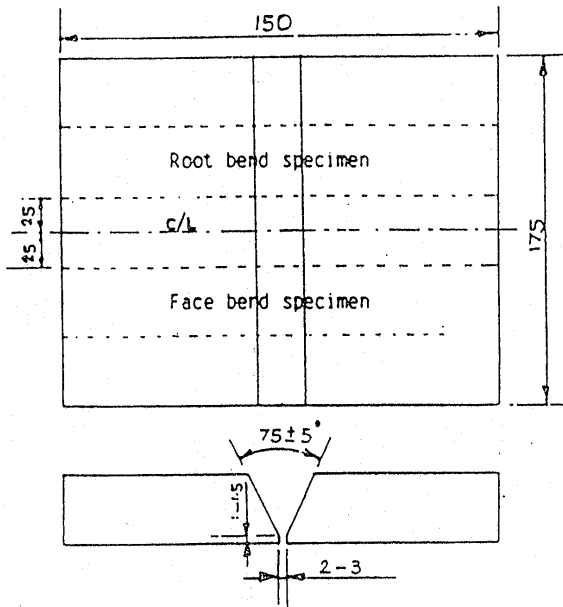
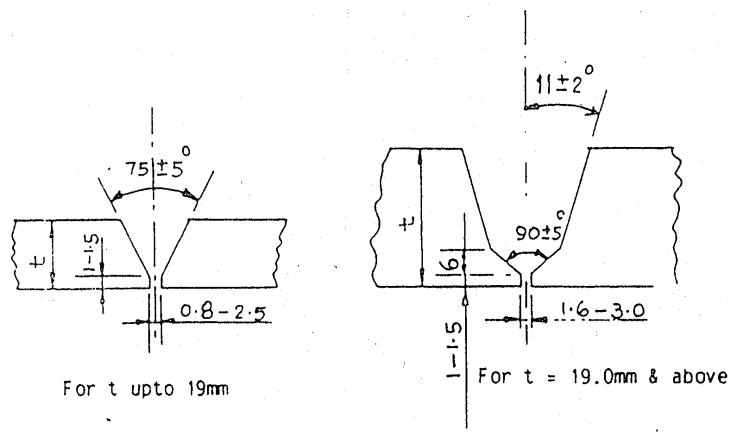
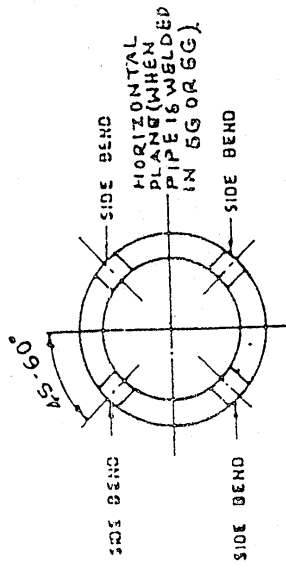

Fig.4: Plate Butt Weld Specimen



All dimensions in mm

Fig.5: Pipe Butt Weld Specimen



PIPE TEST COUPON

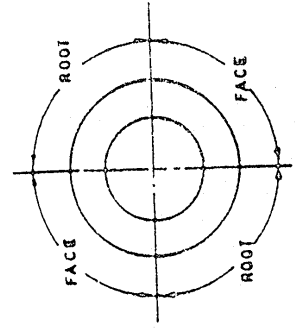

PIPE TEST COUPON

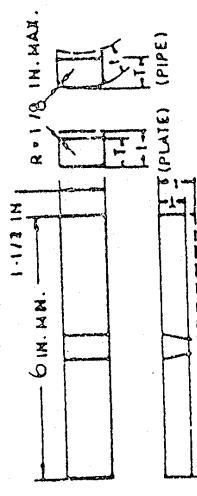
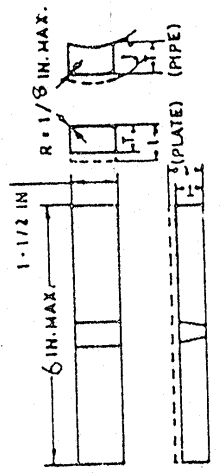

ROOT BEND SPECIMEN - PLATE AND PIPE

FACE BEND SPECIMEN - PLATE AND PIPE

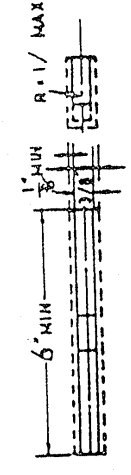
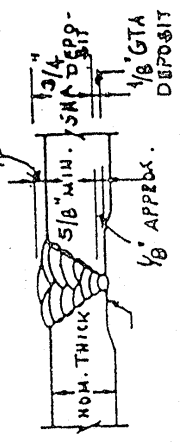

SIDE BEND

Figure - 6

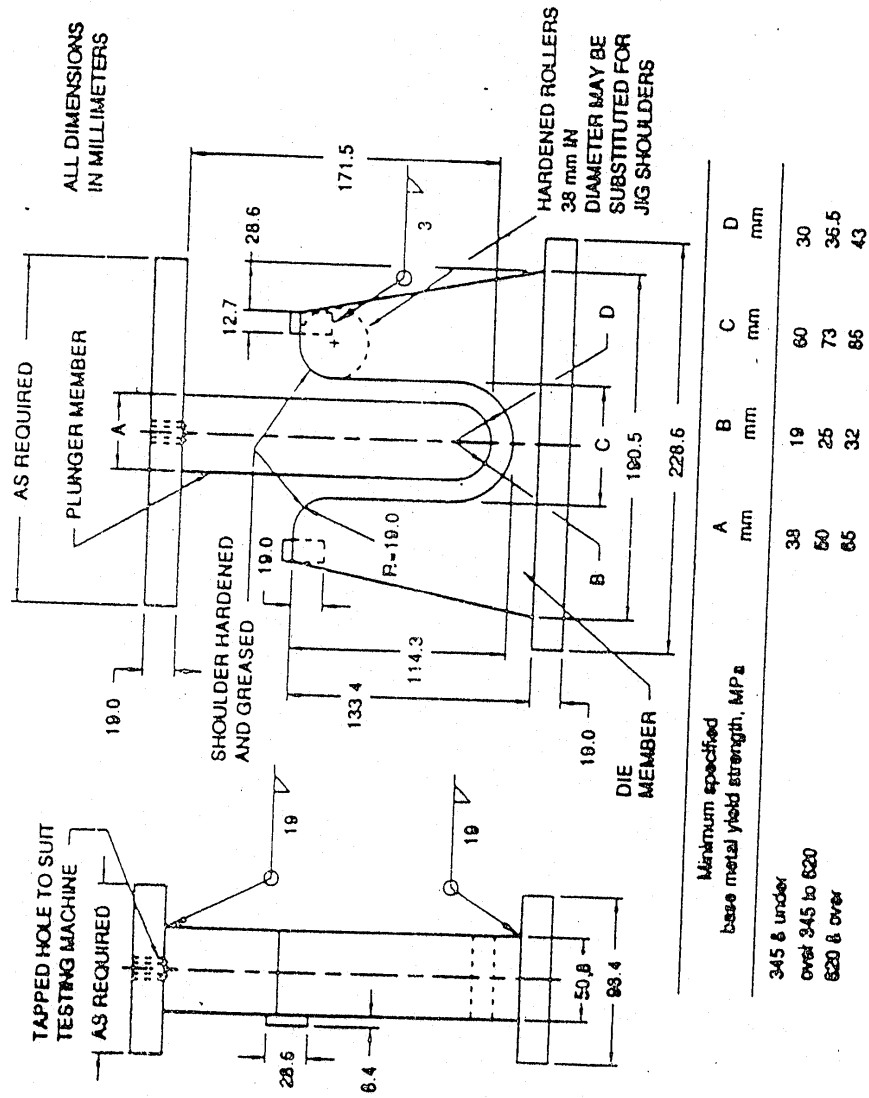

Figure - 7

RECORD OF WELDER PERFORMANCE QUALIFICATION TEST

**Performance Test No.,
Date :**

Site :

Welder's Name & Address :

Welder Code :

Material groupings permitted :
Thickness Qualified :
(This performance test is as per
Procedure No.

Welding Processes :
Position(s) Qualified :
Dia Qualified :

TEST MATERIAL

Specification :
Thickness (and Dia. Of Pipe) :
Shielding Gas(es)

Filler Metal :
SFA No. :
AWS Classification :

PROCESS VARIABLES

Position of test weld :

Current :

Polarity :

Pre-heat temp ;
Test joints

inter Pass Temp:

Post-heat Temp :

Test Results

Type Bend

Results

Type Bend

Results

Type Bend

Results

Type Bend

Results

Radiography Ref. & Results :

(Sketch)

Welder's signature

Agency Conducting Test

We certify that the statements in this record are correct and that the test weld were prepared, welded and tested in accordance with requirements.

This is valid upto -----

Welding In-charge / BHEL.

INSPECTION OF WELDING

1.0 Purpose :

This procedure provides details for performing visual inspection of weld fit-ups, welding in progress and completed welds.

2.0 Reference :

2.1 Contract drawings

2.2 Erection welding schedule (supplied by Units) or equivalent.

2.3 Welding procedure specification, where supplied.

2.4 Indian Boiler Regulations (for boilers erected in India).

3.0 General Requirements :

3.1 Ensure that the components to be welded are in accordance with the contract drawings, Welding Schedule and other relevant documents.

3.2 The condition of welded Surfaces to be inspected must be clean and dry.

3.3 There shall be sufficient lighting to allow proper interpretation of visual inspection.

4.0 Weld fit-up Inspection :

4.1 The surface to be welded shall be smooth and free from deep notches, irregularities, scale, rust, oil, grease and other foreign materials.

4.2 Piping, tubing and headers to be jointed shall be aligned within allowable tolerances on diameters, wall thicknesses and out-of-roundness as below:

Maximum Permissible out-of-alignment at bore

Bore (mm)	Max. Misalignment (mm)	
	For GTAW	For SMAW
Upto 100	1.0	1.0
Over 100 to 300	1.6	1.6
Over 300	1.6	2.4

- 4.3 When fit, components to be welded shall not show an appreciable off-set or misalignment when viewed from positions apart.
- 4.4 The root opening of components to be joined shall be adequate to provide acceptable penetration.
- 4.5 On fillet welds, the parts to be jointed shall be brought as close to contact as practical, although in most instances a small opening between the parts is desirable.
- 4.6 Root gaps should be maintained at 1.6 mm – 2.4 mm (refer relevant document).
- 4.7 Weld area should be protected from drafts and wind, to maintain inert gas shield.
- 5.0 Checks during welding operation:
 - 5.1 Ensure the required minimum preheat temperature is applied and established during welding.
 - 5.2 Ensure correct electrode / filler metal is used for welding.
 - 5.3 Tack welds are examined by the welder before they are incorporated in the final weld.
 - 5.4 Ensure proper drying / holding of electrodes prior to use.
 - 5.5 Ensure the correct interpass temperature is maintained.
 - 5.6 Ensure proper cleaning of weld between beads.
- 6.0 Checks on the completed weld:
 - 6.1 No visible cracks, pin-holes or incomplete fusion.
 - 6.2 The weld surface must be sufficiently free of coarse ripples, grooves, overlaps, abrupt ridges and valleys, visible slag inclusions, porosity and adjacent starts and stops.
 - 6.3 Undercuts not to exceed 1 mm.
 - 6.4 Where inside surface is readily accessible, the same shall be inspected for excess penetration and root concavity. The permissible limits are given below.

Root concavity: max of 2.5 mm or 20% of thickness at weld, whichever is lesser, provided adequate reinforcement is present.

Excess penetration: upto and including 3.2 mm.

- 6.5 For plate butt welds, the weld reinforcement should not exceed 3.2 mm.
- 6.6 For circumferential joints in piping and tubing the maximum weld reinforcements permitted are given below:

Maximum Permissible Reinforcements

Thickness of of base metal	For service above 400 Deg.C	Temperature upto & incl. 400 Deg.C
Upto 3.2	1.6	2.4
Over 3.2 – 4.	1.6	3.2
Over 4.8 – 12.7	2.4	4.0
Over 12.7 – 25.4	3.2	4.8
Over 25.4	4.0	6.3

All Dimensons in mm

- 6.7 There shall be no overlaps.
- The faces of fillet welds are not excessively convex or concave and the weld legs are of the proper length.
- 6.8 In case of weld joints in pressure parts and joints like ceiling girder, the weld joint must be suitably identified.

WELDER PERFORMANCE MONITORING

- 1.0 Purpose:
 - 1.1 This procedure deals with monitoring the performance of welders engaged at sites. This procedure is applicable where radiography is performed.
- 2.0 Procedure:
 - 2.1 The welder performance shall be monitored on a calendar month basis.
 - 2.2. Extent of radiography shall be representative of weekly outputs of the welder.
 - 2.3 Quantum of radiography shall be as per contractual requirements.
 - 2.4 Evaluation of welds radiographed shall be as per NDE manual or other documents as specifically applicable.
 - 2.5 Welder performance evaluation:
 - 2.5.1 For welds dia 88.9 mm and below:
 - 2.5.1.1. The percentage defectives (repairable) is calculated as a percentage of number of unaccepted to those radiographed.
 - 2.5.1.2 Upto and including 5% defectives performance is satisfactory else unsatisfactory.
 - 2.5.2 For welds over dia 88.9 mm and plate welds:
 - 2.5.2.1 The percentage defectives is calculated as a percentage of length of defectives repairable to the length radiographed.
 - 2.5.2.2 Upto an including 2.5% defectives performance is satisfactory else unsatisfactory.
 - 2.6 When a welder gives unsatisfactory performance for a continuous period of 3 months he shall be requalified
 - 2.6.1 Requalification of welder shall be called for when there is a specific reason to question his ability to make acceptable welds. This shall override requirements of cl.2.6
 - 2.7 Welds produced during any month shall be radiographed and evaluated latest by 10th of the succeeding month.

2.7.1 Under circumstances when cl.2.7 is not satisfied for any particular welder, he may be disengaged from the job till such time his performance can be evaluated for the month in study.

2.7.2 Site in-charge may waive the restriction imposed in 2.7.1 reviewing the situations for non-compliance of cl.2.7 and may allow engagement of the welder in question for a period not exceeding one successive month to the month in study.

3.0 Records:

3.1 Welding in-charge shall prepare and maintain Welder Performance Records, welderwise.

REPAIR WELDING

- 1.0 Purpose:
- 1.1 This procedure details steps to be taken for weld repairs.
- 2.0 Procedure:
- 2.1 Unacceptable welds, based on visual inspection or NDE, shall be repaired.
- 2.2 Removal of Defects:
 - 2.2.1 The identified defect area shall be marked on the part.
 - 2.2.2 The defects may be removed by grinding / thermal gouging.
 - 2.2.2.1 Where thermal gouging is done, adopt the requirements of preheating as detailed in Heat Treatment Manual.
 - 2.2.2.2 However, only grinding is permitted for the last 6 mm from the root.
- 2.3 Removal of defects shall be verified by visual inspection PT, MT, RT as appropriate.
- 2.4 The profile of ground portion shall be smooth and wide enough to permit proper fusion during repair welding.
- 2.5 Repair welding shall be carried out as per the procedure for the initial weld.
- 2.6 Repair weld shall undergo the same type of NDE as the initial weld.
- 2.7 Repeat steps 2.1 to 2.6 till acceptable weld is made.
- 2.8 Where cutting, re-edge preparation and re-welding the joint will yield better results, the same shall be followed.
- 3.0 Where a specific repair procedure is supplied by the Manufacturing Unit, the same shall be followed.
- 4.0 Records:
 - 4.1 Records pertaining to the repairs like Welder, NDE records shall be maintained

APPENDIX A

Recommended Electrical Characteristics for Welding at Sites.

Electrical Classification	Process	Dia mm	Current		Voltage range
			Type	Amp range	
&&	GTAW	2.5	DCEN	70-120	12-20
		3.15	DCEN	110-160	12-20
E6013	SMAW	2.5	DCEP	50-100	18-26
		3.15	DCEP	90-140	18-26
		4.0	DCEP	130-190	18-26
@@ EXX18	SMAW	2.5	DCEP	70-120	18-26
		3.15	DCEP	100-160	18-26
		4.0	DCEP	150-220	18-26
## EXXX	SMAW	2.5	DCEP	70-100	18-26
		3.15	DCEP	100-140	18-26
		4.0	DCEP	120-170	18-26

Notes:

&& - The current ranges are applicable for all filler materials used in GTAW process

@@ - EXX18 include E7018, E7018-1, E7018-A1, E8018 B2, E9018 B3.

- EXXX include E309, E347 electrodes.

APPENDIX – B

Extract from AWS D 1.1. 1992

SAFE PRACTICES (Non-mandatory Information)

(This Appendix is not a part of ANSI/AWS D1.1-92, Structural Welding Code-Steel, but is included for information purposes only)

This appendix covers many of the basic elements of safety general to arc welding processes. It includes many, but not all of the safety aspects related to structural welding. The hazards that may be encountered and the practices that will minimize personal injury and property damage are reviewed here.

J1 Electrical Hazards

Electric shock can kill. However, it can be avoided. Live electrical parts should not be touched. Read and understand the manufacturer's instructions and recommended safe practices. Faulty installation, improper grounding, and incorrect operation and maintenance of electrical equipment are all sources of danger.

All electrical equipment and the work pieces should be grounded. A separate connection is required to ground the workpiece. The work lead should not be mistaken for a ground connection.

To prevent shock, the work area, equipment, and clothing should be kept dry at all times. Dry gloves and rubber soled shoes should be worn. The welder should stand on a dry board or insulated platform.

Cables and connectors should be kept in good condition. Worn, damaged, or bare cables should not be used. In case of electric shock, the power should be turned off immediately. If the rescuer must resort to pulling the victim from the live contact, nonconducting materials should be used. A physician should be called and CPR continued until breathing has been restored, or until a physician has arrived. See references 8,7 and 10

J2 Fumes and Gases

Many welding, cutting and allied processes produce fumes and gases which may be harmful to one's health. Fumes and solid particles originate from welding consumables, the base metal, and any coating present on the base metal. Gases are produced during the welding process or may be produced by the effects of process radiation on the surrounding environment. Everyone associated with the welding operation should acquaint themselves with the effects of these fumes and gases.

The possible effects of over-exposure to fumes and gases range from irritation of eyes, skin and respiratory system to more severe complications. Effects may occur immediately or at some later time. Fumes can cause symptoms such as nausea, headaches, dizziness, and metal fumes fever. Sufficient ventilation, exhaust at the arc, or both, should be used to keep fumes and gases from breathing zones and the general work area.

For more detailed information on fumes and gases produced by the various welding processes, see References 1,4 and 11

J3 Noise

Excessive noise is a known health hazard. Exposure to excessive noise can cause a loss of hearing. This loss of hearing can be either full or partial, and temporary or permanent. Excessive noise adversely affects hearing capability. In addition, there is evidence that excessive noise affects other bodily functions and behavior. Personal protective devices such as ear muffs or ear plugs may be employed. Generally, these devices are only accepted when engineering controls are not fully effective. See References 1,5 and 11.

J4 Burn Protection

Molten metal, sparks, slag, and hot work surfaces are produced by welding, cutting and allied process. These can cause burns if precautionary measures are not used.

Workers should wear protective clothing made of fire resistant material. Pant cuffs or clothing with open pockets or other places on clothing that can catch and retain molten metal or sparks should not be worn. High top shoes or leather leggings and fire resistant gloves should be worn. Pant legs should be worn over the outside of high top boots. Helmets or hand shields that provide protection for the face, neck, and ears, should be worn, as well as head covering to protect. Clothing should be kept free of grease and oil. Combustible materials should not be carried in pockets. If any combustible substance is spilled on clothing it should be replaced with fire resistant clothing before working with open arcs or flame.

Appropriate eye protection should be used at all times. Goggles or equivalent also should be worn to give added eye protection.

Insulated gloves protection should be worn at all times when in contact with hot items or handling electrical equipment.

For more detailed information on personnel protection Reference 2,3,8 and 11 should be consulted.

J5 Fire Prevention

Molten metal, sparks, slag, and hot work surfaces are produced by welding, cutting, and allied processes. These can cause fire or explosion if precautionary measures are not used.

Explosions have occurred where welding or cutting has been performed in spaces containing flammable gases, vapours, liquid, or dust. All combustible material should be removed from the work area. Where possible, move the work to a location well away from combustible materials. If neither action is possible, combustibles should be protected with a cover or fire resistant material. All combustible materials should be removed or safely protected within a radius of 35 ft. (11m) around the work area.

Welding or cutting should not be done in atmospheres containing dangerously reactive or flammable gases, vapours, liquid, or dust. Heat should not be applied to a container that has held an unknown substance or a combustible material whose contents when heated can produce flammable or explosive vapours. Adequate ventilation should be provided in work areas to prevent accumulation of flammable gases, vapours or dusts. Containers should be cleaned and purged before applying heat.

For more detailed information on fire hazards from welding and cutting operations, see References 6,8,9 and 11

J6 Radiation

Welding, cutting and allied operations may produce radiant energy (radiation) harmful to health. Everyone should acquaint themselves with the effects of this radiant energy.

Radiant energy may be ionizing (such as X-rays) or non-ionizing (such as ultraviolet, visible light, or infrared). Radiation can produce a variety of effects such as skin burns and eye damage, if excessive exposure occurs.

Some processes such as resistance welding and cold pressure welding ordinarily produce negligible quantities of radiant energy. However, most arc welding and cutting processes (except submerged arc when used properly), laser welding and torch welding, cutting, brazing, or soldering can produce quantities of non-ionizing radiation such that precautionary measures are necessary.

Protection from possible harmful radiation effects include the following:

- 1) Welding arcs should not be viewed except through welding filter plates (see Reference 2)
- 2) Transparent welding curtains are-not intended as welding filter plates, but rather, are intended to protect passers by from incidental exposure.

- 3) Exposed skin should be protected with adequate gloves and clothing as specified. See Reference 8.
- 4) The casual passerby to welding operations should be protected by the use of screens, curtains, or adequate distance from aisles, walkways, etc.
- 5) Safety glasses with ultraviolet protective side shields have been shown to provide some beneficial protection from ultraviolet radiation produced by welding arcs.

References Cited

1. American Conference of Governmental Industry Hygienist (ACGIH). Threshold limit values for chemical substances and physical agents in the workroom environment, Cincinnati, Ohio; American Conference of Governmental Industry Hygienists(ACGIH)
2. American National Standards Institute. Practice for occupational and educational eye and face protection, ANSI Z87.1 New York: American National Standards Institute.
3. -----Safety-toe footwear, ANSI Z41.1 New York: American National Standards Institute.
4. -----American Welding Society. Fumes and gases in the welding environment, AWS Report. Miami, Florida: American Welding Society.
5. -----Method for sound level measurement of manual arc welding and cutting processes, ANSI / AWS F6.1. Miami, Florida.
6. -----Recommended safe practices for the preparation for welding and cutting containers that have held hazardous substances, ANSI/AWS F4.1. Miami, Florida: American Welding Society.
7. -----Safe Practices.(Reprint from Welding Handbook, Volume 1, Eight Edition) Miami, Florida: American welding Society.
8. ----- Safety in welding and cutting, ANSI/ASC Z49.1 Miami, Florida: American Welding, society.
9. National Fire Protection Association: Cutting and welding processes NFPA Standard 51B. Quincy, Massachusetts: National Fire Protection Association
10. ----- National Electrical Code. NFPA No.70.Quincy, Massachusetts National Fire Protection Association.
11. Occupational Safety and Health Administration. Code of Federal Regulations, Title 20 Labour, Chapter XVII, Part 1910; OSHA General Industry Standards. Washington, DC:U.S Government Printing Office.

APPENDIX A

MINIMUM REQUIREMENTS OF NDE AS PER IBR

(Quantum of Radiography or other approved NDE methods for Butt Welds)

1.0 Boiler and Superheater Tubes (Regulation No.151 (h):

BORE, MM	PERCENTAGE OF NDE
OVER 178	100%
OVER 102 AND UPTO 178 INCLUDING	10% (MIN. 2 WELDS PER WELDER)
BELOW 102	5% (MIN 1 WELD PER WELDER)

2.0 Steam pipes and fittings (Regulation No.360 (d) – NDE Requirements:

2.1 Pipelines NDE requirement:

DESCRIPTION	BORE mm	PERCENTAGE OF NDE FOR EACH WELDER	PERCENTAGE OF CUTOUT JOINTS FOR VISUAL AND BEND TEST FOR EACH WELDER
CLASS I PIPELINES: A. WHERE THE COMPLETED PIPELINES ARE NOT SUBJECTED TO HYDRAULIC TEST	OVER 102	100%	—
	OVER 38 AND UPTO 102 INCLUDING BELOW 38	5% (MIN. 2 WELDS PER WELDER)	2% (Note.1)
B:WHERE THE COMPLETED PIPELINES ARE SUBJECTED TO HYDRAULIC TEST	OVER 102	10% (MIN. 2 WELDS PER WELDER)	—
	OVER 38 AND UPTO 102 INCLUDING BELOW 38 mm	2% (MIN 1 WELD PER WELDER)	2% (Note.1)
CLASS II PIPELINES: ALL PIPES	ALL SIZE	—	2% (Note –1)

Note. 1: It is suggested that in lieu of this radiography may be substituted at sites.

2.2 Retest:

If any test specimen is unsatisfactory, two further weld specimen for retest shall be selected from the production welds and subjected to tests.

APPENDIX B

Extract from ASME/ ANSI B 31.1/1992 MANDATORY MINIMUM NDE for pressure welds or welds to pressure retaining components.

- I. Piping service conditions temperature over 400 deg C and all pressures.

Type of weld	NDE
Butt welds	RT for over NPS 50 MT-& PT for NPS 50 And less
Fillet, Socket, attachment & seal welds	MT or PT for all sizes and Thicknesses

- II Piping service conditions: Temperatures between 175 deg C Inclusive and 400 deg C inclusive with all pressures above 7100 kPa(gauge)

Type of weld	NDE
Butt welds	RT for over NPS 50 with Thickness over 19 mm. Visual For others.
Fillet, socket, attachment and seal weld	Visual for all sizes & Thicknesses.

- III All others : Visual examination.

NOTES: 1) NPS - nominal pipe size

- 2) All welds must be given a visual examination in addition to the NDE specified.
- 3) The thickness of buttwelds is defined as the thicker of the two abutting ends after end preparation
- 4) Temperatures and pressures shown are design.
- 5) Fillet welds not exceeding 6 mm throat thickness which are used for the permanent attachment of nonpressure retaining parts are exempt from the PT & MT requirements.

APPENDIX C

NDE Requirements as per ASME Sec – I

Following buttwelds shall be radiographed or ultrasonically tested.

- A. For drums, shells excluding pipes, tubes, headers.
 - I NPS exceeding 250 mm or wall thickness greater than 28 mm. Bring against (B. For pipes, tubes and headers. Radiography is not mandatory for the following conditions.)
 1. For parts containing steam: NPS \leq 400 mm or wall thickness \leq 40 mm
 2. For parts containing water : NPS \leq 250 mm or wall thickness \leq 28 mm
 3. For parts in flue gas path but not subject to radiation: NPS \leq 150 mm or wall thickness \leq 19 mm
 4. For parts in flue gas path and subject to radiation: NPS \leq 100 mm or wall thickness \leq 12.5 mm
 - II Where radiography is to be performed and geometric unsharpness cannot be within 1.8 mm, ultrasonic testing shall be performed.

Note: NPS – nominated pipe size

HEAT TREATMENT

1.0 Purpose:

1.1 This procedure provides information, method and control for preheat (PH) and post weld heat treatment (PWHT) of welds at sites.

2.0 Document:

2.1 The following documents are referred in preparation of this procedure.

2.1.1 ASME Sec.1, II(a)

2.1.2 ANSI B 31.1

2.1.3 Indian Boiler Regulations

2.1.4 AWS D1.1/Steel

2.1.5 Welding Manual – PS:CMX:001:00:93

2.2 The following are referred to as Primary Documents

- Erection Welding Schedules or equivalent
- Contract Drawings
- Plant Standards, where supplied
- Welding Procedure Specification, where supplied

2.2.1 Where parameter for Preheating (PH) and PWHT are not available in the primary documents reference may be made to this manual.

2.2.2 Where such parameters are not contained either in the primary documents or in this manual reference may be made to Manufacturing Units.

3.0 Procedure:

3.1 Preheating:

3.1.1 When parts of two different thicknesses are welded together, the preheating requirements of the thicker shall rule.

3.1.2 When parts of two different P numbers are jointed together, the material requiring higher preheat shall govern (Please refer Welding Manual for P numbers)

3.1.3 Preheating shall be checked using thermal chalk (temperature indicating crayons) prior to start-up welding as well as at frequent intervals during welding. It is preferable to have a thermocouple and a temperature recorder in case of alloy steels of thickness greater than 50 mm.

3.1.4 In case of any interruption during welding, preheating temperature shall be maintained at joint by wrapping in dry thermal insulating blankets to ensure slow and uniform cooling.

3.1.5 Preheating Methods:

3.1.5.1 Preheating shall be applied by any of the methods given below:

- a. Electrical Resistance Heaters
- b. Induction Heating
- c. Oxy-Acetylene or other Gas Torches

3.2 Post Weld Heat Treatment(PWHT):

3.2.1 The method shall be by locally heating a circumferential band including the entire weld and adjacent area of base metal, by Induction or Electrical Resistance Heating.

3.2.2 Heat Band for PWHT

3.2.2.1 For Boilers:

- a. When heat treating welded joints in components in the boiler, proper width of the heated circumferential band on either side of the weld.

(W) must be as, $W = 3$ times the width of the widest part of the weld groove but in no case, less than twice the width of weld at reinforcement.

- b. When used in post weld heat treatment in sections – $W = 3$ times the plate thickness.

- c. For nozzle and other welded attachments – $W =$ must be wider than the nozzle or attachment or 3 times the wall thickness.

3.2.2.2 For Piping:

$W =$ Three times the wall thickness of thickest part, in case of nozzles and attachment welds, the width of the heat band shall extend beyond the nozzle or the attachment wall on each side by at least twice the higher thickness and shall extend completely around the header.

AMENDMENT NO : 1

3.2.2.3 Other Pressure Vessels:

Heat band width, placement of thermocouple and preheat and PWHT information shall be obtained from the supplier.

3.3 Condition of Welded Joints:

3.3.1 The weldment shall be free of grease, oil etc, prior to PH/PWHT.

3.4 Temperature Measurement for PWHT:

3.4.1 Post weld heat treatment temperature shall be measured and monitored by use of thermocouples with calibrated recorders.

3.4.2 The periodicity of calibration of the equipment must be every twelve months or before use.

3.4.3 Where the soaking temperature is found to be lesser than specified, the PWHT cycle shall be repeated.

3.4.4 In case interruption during PWHT, the following actions are to be taken depending on the stage during which interruption occurred.

a. Interruption during heating cycle:

- The whole operation to be repeated from the beginning

b. Interruption during soaking:

- The joint can be treated subsequently for the balance left over soaking period.

c. Interruption during cooling:

- Ensure slow cooling by covering with insulation to a minimum width of 1.5 times the outer diameter applied equally about the central line of weld, till the temperature reaches around 350 deg.C.

- 3.5 THERMOCOUPLE (t / c) Fixing:
- 3.5.1 Thermocouples shall be used for recording post weld Heat Treatment temperatures.
- 3.5.1.1 Following are guidelines regarding number and placement of thermocouples.
- 3.5.1.2 Minimum of two thermocouples per weld.
- 3.5.1.3 Thermocouples located 180 deg. Apart.
- 3.5.1.4 Thermocouples located top and bottom of weld.
- 3.5.1.5 Thermocouples located at a distance of approximately 1.5 times of the wall thickness about the centre line of weld.
- 3.5.2 The following guidelines may be used for attaching thermocouples to job.
- a. For capacitor discharge method: Thermocouple elements should be attached within 6 mm of each other.
 - b. For other type of t / c Insert the elements in a ss tube of internal diameter approximately 6 mm. Apply force on tube and crimp it. Place this t / c and weld the crimped button to the pipe in area of interest. Do not weld the elements.
 - c. Insulate the t / c leads suitably and protect t / c ends from direct radiation from heating elements.
- 3.5.3 For Bunched Tubes:
- 3.5.3.1 Where a bunch of closely placed tube welds (e.g Super Heater / Reheater Coils) require to be stress relieved, the same shall be grouped together as if they form a single component.
- 3.5.3.2 In such cases attachment of a minimum of three thermocouples, two at the end tubes and one at the middle is recommended.
- 3.6 Soaking Time
- 3.6.1 Wherever not specified the soaking time shall be 2.5 minutes per mm. The minimum soaking shall be 30 minutes.

- 3.6.2 The following guidelines shall be used to determine the thickness and subsequent selection of the soaking time of PWHT.
- a. For butt welds, the thickness shall be the thickness of the material at the weld. For bar stock, the thickness shall be the diameter.
 - b. For fillet welds, the thickness shall be the throat thickness.
 - c. For partial penetration branch welds, the thickness shall be the depth of the groove prior to welding.
 - d. For repairs, the thickness shall be the depth of the groove as prepared for repair welding.
 - e. For combination of different welds in a component, the maximum thickness in the definitions given above shall govern.
- 3.6.3 Soaking time is to be reckoned from the time temperature of the joint crosses the recommended lower temperature of the cycle, to the time it comes down below the same recommended lower temperature of the cycle.
- 3.7 Heating and Cooling rates:
- 3.7.1 Whenever not specified, the heating rate above 400 deg. C and cooling rate after soaking upto 400 deg.C shall be as follows. This is applicable for all materials other than BS 3604:622 and 660 materials.

Thickness of Material	Maximum Heating Rate Above 400 Deg.C	Maximum Cooling Rate Upto 400 Deg.C
Upto and including 25 mm	220 Deg. C / Hour	110 Deg.C / Hour
Over 25 to 50 mm (incl)	110 Deg. C / Hour	110 Deg.C / Hour
Over 50 to 75 mm (incl.)	75 Deg. C / Hour	110 Deg.C / Hour
Over 75 mm	55 Deg. C / Hour	110 Deg.C / Hour

For Structural – 65 deg. C / Hour (Max.)

3.7.2 For BS:3604:622 and 660 materials, for a combination of diameter below 127 mm and thickness below 12.5 mm, maximum rate of heating is

$\frac{250 \times 25}{T}$ or 100 deg.C / Hour, whichever is less.

Maximum rate of cooling is 50 deg C / hour.

T = Thickness of material in MM.

3.8 Temperature Records:

3.8.1 All the heat treatment cycles may be controlled within a tolerance of + or - 20 deg. C around the recommended temperature. The recommended temperature for stress relieving must be selected as the midpoint of recommended range of temperature for the material.

3.9 All the heat treatment cycles may be controlled within + / - 20 deg.C around the midpoint of the recommended range of temperature for the material.

4.0 SR Job Card:

4.1 Prior to start of stress relieving operations, a job card may be prepared including details of weld reference, soaking time, soaking temperature, maximum rates of heating and cooling, temperature recorder details, date of PWHT as per sample format.

4.2 On completion of PWHT the actuals may be recorded on the job card.

4.3 A chart number shall be given to each chart.

5.0 List of Tables:

Table – 1 PH, PWHT for GIRTH BUTT Welds in Tubes and Pipes Dia \leq 76.1 mm.

Table – 2 PH, PWHT for Headers

Table – 3 PH, PWHT for Pipes Dia $>$ 108 mm

Table – 4 Heat Treatment requirements for Non-Pressure Parts including Structurals.

Table – 5 PH for Flame Cutting

Annexure – 1 Soaking Time

Annexure – 2 Heat Treatment of X-20 materials.

6.0 Records:

6.1 Pertinent Records like Job Card, SR Charts, shall be maintained.

STRESS RELIEF (S.R) JOB CARD

Site: -----

Date: -----

Unit No. -----

Package: -----

Description -----

Temp. Recorder Details

Weld Reference -----

1. Make-----

Material Spec:-----

2. Type-----

Size: Dia-----mm

3. Sl.No:-----

Thick---(t) -----mm

4. Calibration
Due on:-----

NDE Cleared on:-----

Thermocouple Locations:

Minimum 2

$d = 1.5 \times t$

Heating Band = $6 \times t$

Insulation Band = $12 \times t$

Date of S.R.-----

Start Time:-----

End Time-----

Chart No.:-----

Required

Actual

Rate of Heating (Max) deg C / h

Soak Temperature deg C

Soak Time (Minutes)

Rate of Cooling(Max) deg C / h

Contractor

B.H.E.L

Results

Accepted / Not Accepted:

Released for further processing

TABLE – I
GIRTH BUTT WELDS
(Tubes and Pipes Dia ≤ 76.1)

Applicable for Thickness upto 19 mm for P1ABC and Thickness
Upto 13 mm for other materials

MATERIAL		PROCESS	P1ABC	P3A	P4Gr.1,2	P5 Gr.1	P5 Gr.2	P8
P1	GTAW SMAW	PH	NIL					
		PWHT	NIL					
P3 Group 1	- do -	PH	NIL	NIL				
		PWHT	NIL	NIL				
P4 Group 1 & 2 (Note 1)	- do -	PH	120	120	120			
		PWHT	NIL	NIL	NIL			
P5 Group 1 (Note 1)	- do -	PH	200	200	200	200		
		PWHT	NIL	NIL	NIL	NIL		
P5 Group 2	- do -	PH	200	200	200	200	200	
		PWHT	680-720	680-720	680-720	680-720	680-720	
P8 Group 1 & Group 2	- do -	PH	NIL	NIL	120	150	200	NIL
		PWHT	NIL	NIL	NIL	NIL	680-775	NIL

Note: Preheating of P4 and P5 tubes can be waived off if PWHT is envisaged at site.

If Preheating is done for the above, PWHT can be waived off subject to the approval from Chief Inspector of Boilers of the respective region.

PH = Preheat; PWHT = Post Weld Heat Treatment.

TABLE – II
PREHEAT AND PWHT TO HEADERS

(Note – 4)

(Applicable for Welding of Header to Header Joints at Site)

Header Pipe Material (Note 3)	Thickness, (mm)	Preheat °C	Post Heating (Note 2) °C	PWHT °C
P1 Group 1 & 2 (Note 1)	t ≤ 25	NIL	NIL	600-650
	t 25 – 75	100	NIL	600-650
	t > 75	150	NIL	600-650
P4 Group 1 & Group 2	t ≤ 75	120	NIL	650-700
	t > 75	150	NIL	650-700
P5 Group 1	Plates & Pipes	150	250 ⁰ for 4 hours	700-750
	Castings & forgings	200		

Note 1: For SA 106 Gr. C materials, a minimum preheat of 100⁰C is required for all thickness and a post heat of 150⁰C for two hours after completion of welding.

Note 2: All P5 headers shall be interstage heat treated at 700-750⁰C for 30 minutes soaking prior to any cold straightening operation. In lieu of this, the straightening can be done after final PWHT.

Note 3: Irrespective of the stub or attachment material, the PWHT cycles shall be governed by the header pipe material. However, the preheat for welding shall be as shown below:

P1 Header to P3 stub	-	120 ⁰ C (min.)
P1 Header to P4 stub	-	120 ⁰ C (min.)
P1 Header to P5 stub	-	150 ⁰ C (min.)

Note 4: Seal welding of hand hole plates, radiographic plugs and screws can be carried out after final PWHT, provided the preheat is carried out as per the table.

Note 5: Soaking time for BS 622 & 660 materials shall be 180 mts. (min) irrespective of thickness. However, when diameter is less than 127 mm and thickness less than 12.5 mm, soaking time shall be 30 minutes (min).

Note 6: Throat shall be as specified in the drawing. Wherever flanges are welded to pipes combined throat shall be taken into consideration.

TABLE - IV

Heat Treatment Requirements for Non Pressure Parts Including Structurals (Note 7)

Material	Shearing	Gas cutting	Thickness	Welding		
	Post Forming Heat Treatment	Preheat		SMAW (Non-Low H ₂ Electrodes)	SMAW (Low H ₂ electrodes) GMAW, SAW etc.	PWHT (Note 7)
P1 A.36 Is 2062 IS 226	t ≤ 19 – Nil t > 19 – 600-650 ⁰ C No<- soaking <- is required. (Note 1)	t ≤ 50 – Nil t > 50, 100 ⁰ C	t ≤ 19 t - 19 – 38 t - 38 – 63 t > 63	Nil 100 120 150	Nil Nil 100 120	a. All butt welds when > 50 mm b. Any welds to a tension member (Note 2) SR at 600-650 ⁰ C
P4	All sheared edges at 650 – 700 ⁰ C for 15 mts.	t ≤ 25 – Nil t > 25, 120 ⁰ C	t < 75 t > 75	--- ---	120 150	a. All butt welds in tension member. b. All fabricated components when t>16 mm (Note 3) SR at 650 – 700 ⁰ C
P5	All sheared edges at 680-730 ⁰ C for 15 mts.	t ≤ 13, 120 ⁰ C t 13 – 25, 150 ⁰ C t > 25, 200 ⁰ C (Note 4)	All	---	150	All welds (Note 5 & 6) SR at 680-730 ⁰ C

- Note 1: Clip angles above 10 mm, used for beam connections, which are sheared to length, shall required heat treatment.
- Note 2 : All tension members, when thickness is above 50 mm, the entire assembly shall be post weld heat treated.
- Note 3 : All fabricated structural components of P-4 material, with any member above 16 mm thickness, the entire assembly shall be post weld heat treated.
- Note 4: All gas cut edges of P-5 material shall be heat treated at 680-730⁰C for 15 mts. As an alternative to this heat treatment, the gas cut edges may be chipped off, ground or machined to remove the HAZ with 6 mm minimum removal.
- Note 5 : All welds of P-5 material shall be post heated at 250⁰C for 2 hours or 150⁰ C for 4 hours immediately following welding.
- Note 6 : All fabricated structural members of P-5 material, the entire assembly shall be post weld heat treated after completion of fabrication.
- Note 7: For soaking time details refer Annexure – I.